



LIFTING PROFESSIONALS



TWO POST LIFTS C-5 WITH BASE

Ref. **13162** **5.000 Kg.** **1.250 Kg.** **400 V. 3+3kW** **40"**

RELIABLE

SOLID

NON DEFORMABLE

SlenderTec™
Super Strength Column Made in Germany

Ours special profiles *SlenderTec™* Super Strength Column Made in Germany allows us to manufacture extremely **resistant** and **less bulky** posts.

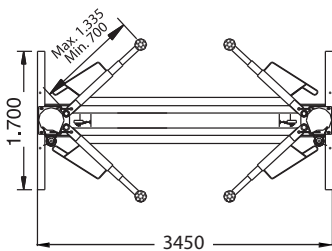

Workspace maximum between posts with the minimum outer space.

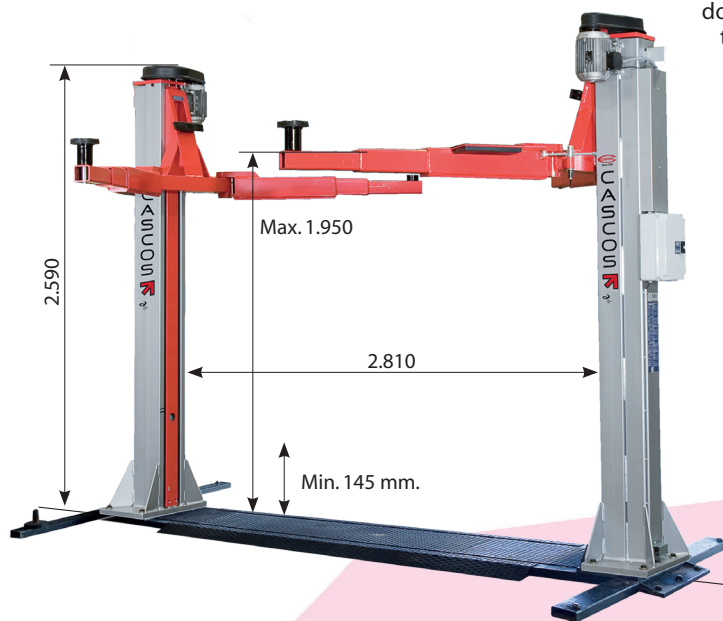

Great space between posts, perfect door opening to enter/exit.



Reversibility



Symmetric lifting arms means **vehicles can be loaded in either direction**, making it much more versatile.



2006/42/CE & EN-1493:2011 European Directives & Approved Standards



After-Sales Quality & Service prize

The design of the mechanical and electrical systems of our lifts makes them **reliable, strong and simple**

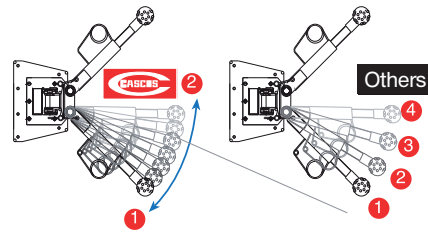
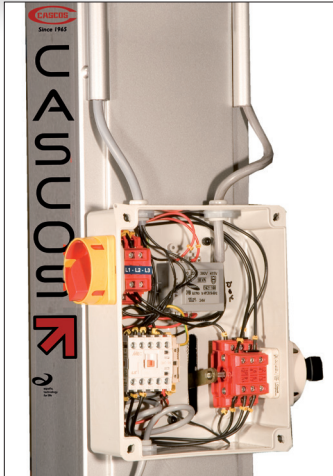

Our locking mechanism, via spindle as opposed to the cog style, allows for far **greater choice of positioning for the operator**.

Exclusive details:

- Tool trays.
- Rubber protections on columns for safe door opening.

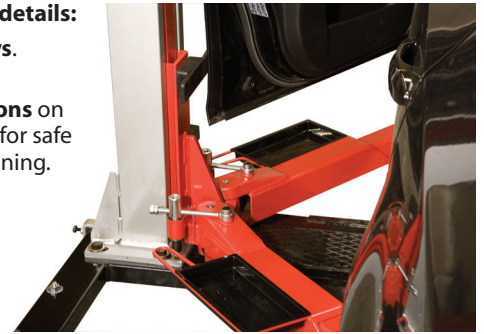

The biggest on the market

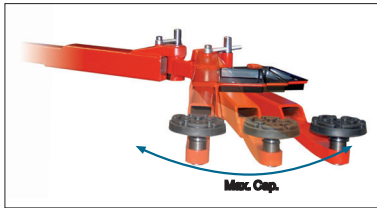
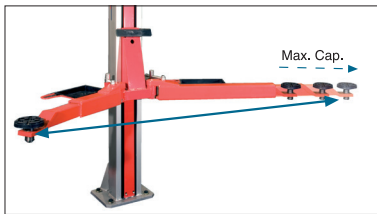

- Max load at:**
- Any opening angle.
 - Arm extension.

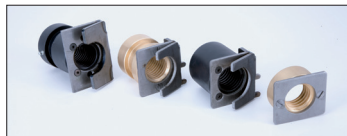
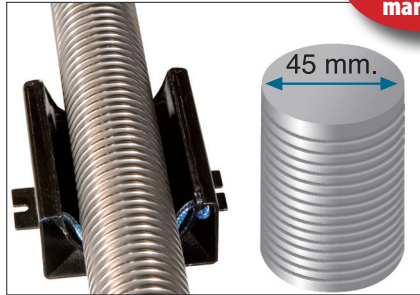

- The biggest diameter spindle on the market** and high quality nuts offer:
- Less wear.
 - Longer lasting life.

High quality guided steel bearings offer longer durability than nylon guides.

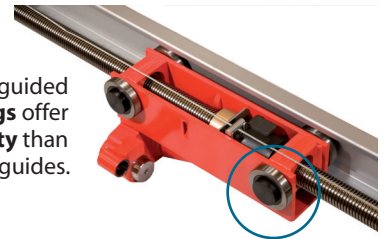

Serial rubber drop in pads

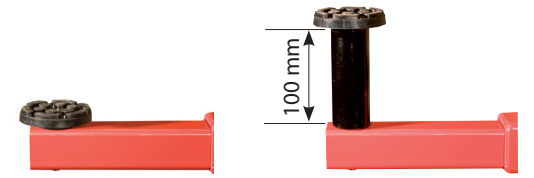

CASCOS supplies its lifts with fixings to the ground.

Accessories

Optional pads

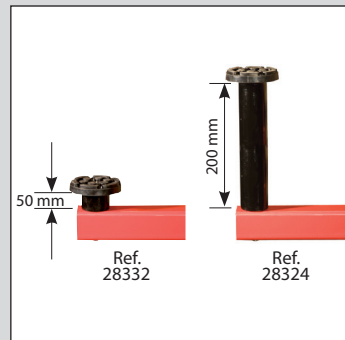

Magnetic holder for tools

