

# CASCOS

LIFTING PROFESSIONALS



## 4 POST LIFTS



# C440 MOT ATL

Type	Ref.	Min	kg			
FLAT PLATFORM with play detector	13353A	135 mm	4Tn	950 Kg.	230-400V/3ph/50Hz/3kW 230V/1ph/50Hz/2,2kW	35"

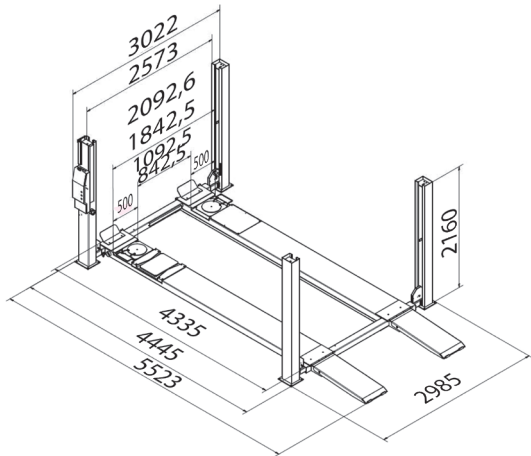

Flat platform with front recessed and play detector.

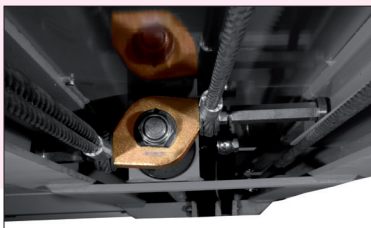
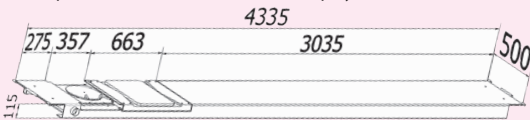

### Security indicator

Indicator that prevents a bad levelling, and ensures that the cylinder works within the best conditions assuring a longer lasting life.



### Hydraulic cylinders

produced and tested one by one in our factory. The cylinders count with the security valves that detects any lack of oil, closing the circuit and preventing the lift from the descending.

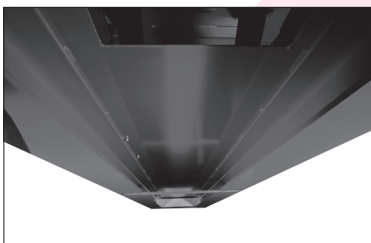

### Our platforms are built with:

Reinforced super structure by double T steel beams for intensive use, keeping the platform flat/straight over the years.



### Security x2

Double security system in each post :

- Mechanical (safety bars)
- Pneumatic (security ladders)

Ensures a better reliability than the electromagnetic security system.

### Minimal height

Our platforms descend almost to the ground level avoiding the use of bulky run-up ramps to allow sport cars to go in (and consequently, using less garage area).



The lowest on the market!

H. Min. 135 mm

### Repairable during at least 10 years.

We ensure spare parts availability during at least this period.



2006/42/CE & EN - 1493:2011  
European Directives  
& Approved Standards



## OPTIONAL EQUIPMENT

### Oleopneumatic Jacks

4 Tn

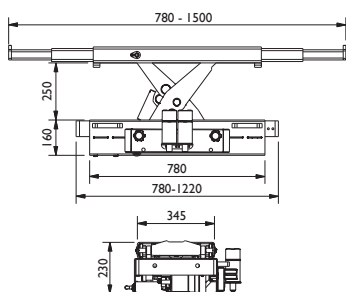
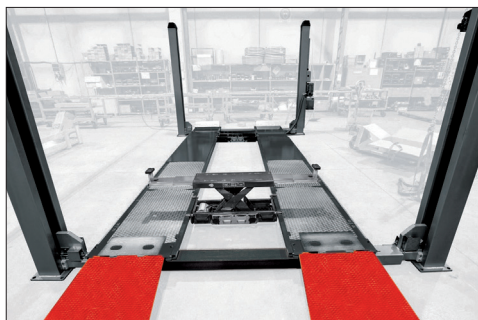

2 - 2,6 Tn

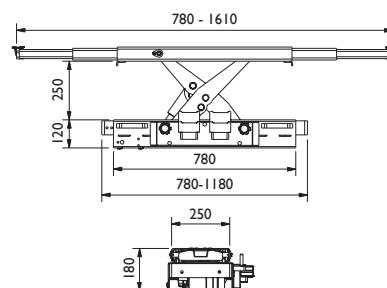

	Without lip	With lip
Capacity	Ref	Ref
2 Tn	50515	50514
2,6 Tn	50517	50516
4 Tn	50565	50552

### Accesories

Magnetic lighting kit

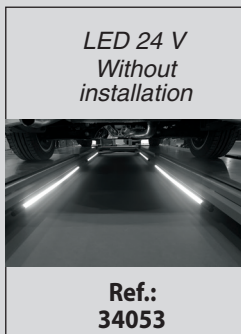

Top Covers



Magnetic holder for tools



Additional buttoning column opposite



Magnetic air Kit



Integrated power plug Assembled in factory

