

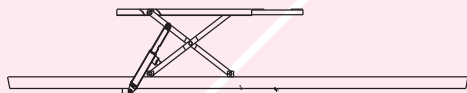

T5.5LX

Ref.				
140229	5.500 Kg	2.860-2.960Kg.	3PH 400/230V- 3Kw 50Hz 1PH 230V-2,2Kw 50 Hz	3,5Tn

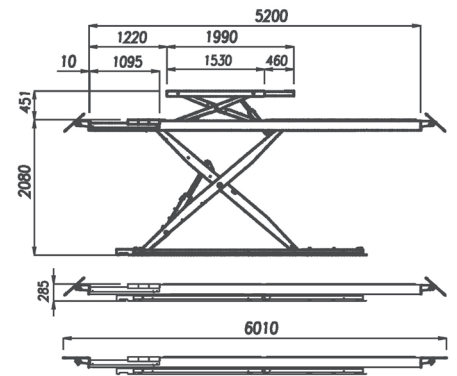

5200 mm x 660 mm x 285 mm

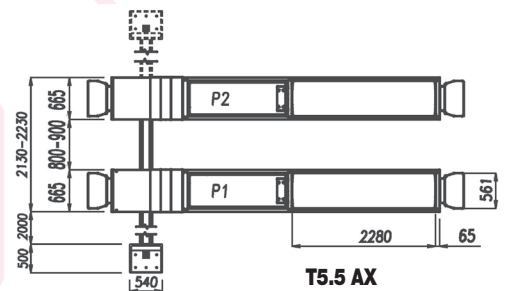

T5.5 AX



Ref. 14987F
Inground
version.

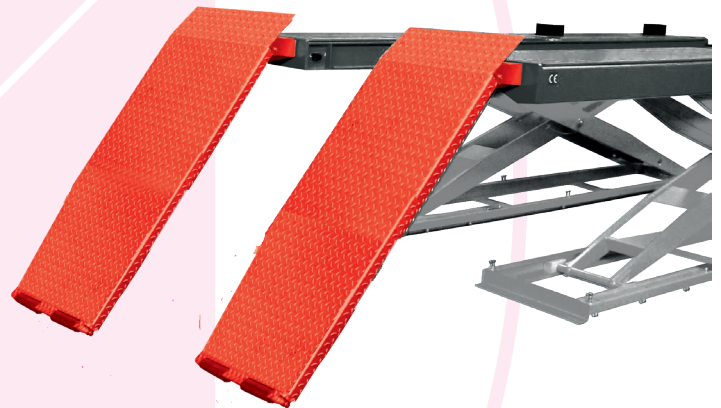

T4: Ref. 14950C
T5.5: Ref. 14950C + 14970F

Onground lift with surface
ramps.



Lift and built in lifting table with double hydraulic circuit
(2 masters + 2 slaves). Hydraulic security .

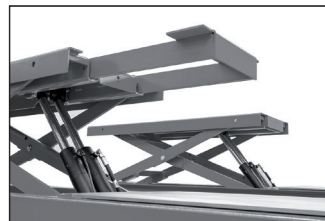

Extending lift table.



Repairable during at least 10 years.
We ensure spare parts availability during at least this period.



Includes manual descend pump, regulator of the pneumatic pressure and water filter separator.



Very solid structure and base "solid profiles".



Reinforce base of the lift -150 kg.- equipped with **16 regulation points.**



Includes sliding guide for Jacking Beams.

Accessories

Olepneumatic Jacks

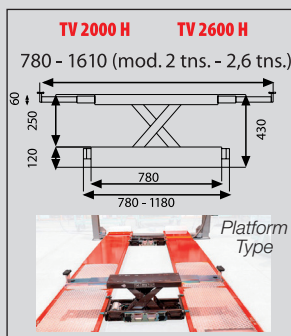

Recess infills kit



T4 Ref.: 94345
T5.5 Ref.: 94346

Extension ramp

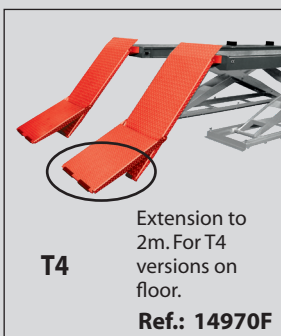

T4 Extension to 2m. For T4 versions on floor.
Ref.: 14970F

Lightning kit



LED 24 V

No compatible with Jacking Beams.

Ref.: 34044

Rubber pads

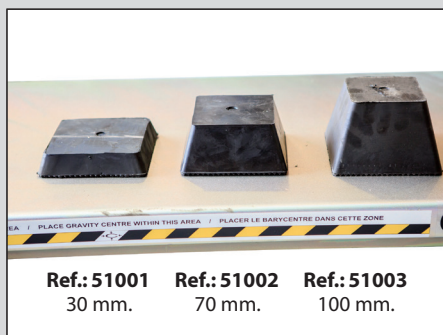

Ref.: 51001 30 mm. Ref.: 51002 70 mm. Ref.: 51003 100 mm.

Set of shock absorbers

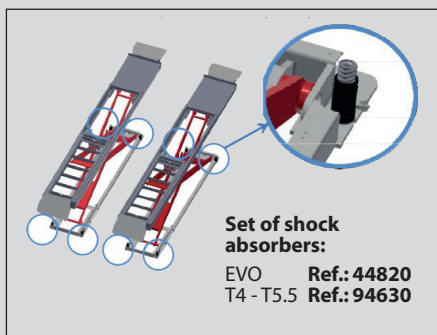

Set of shock absorbers:
EVO Ref.: 44820
T4 - T5.5 Ref.: 94630

Hose kit

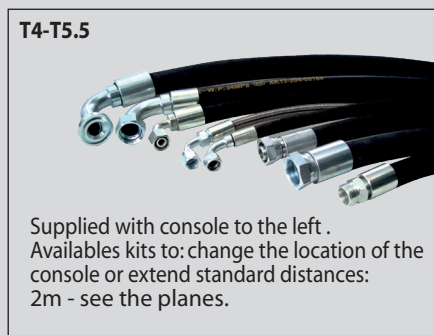

T4-T5.5

Supplied with console to the left. Available kits to: change the location of the console or extend standard distances: 2m - see the planes.